

# MotionProtect Plus Fibra

Wired indoor IR motion detector with additional K-band microwave sensor to filter thermal interferences.



The device is compatible only with hubs supporting Fibra protocol. Find the detailed information by QR code or the link:

<https://ajax.systems/support/devices/motionprotect-plus-fibra/>

MotionProtect Plus Fibra is the device of the new Fibra wired product line. Such devices can only be purchased, installed and administered by accredited Ajax Systems partners.



Up to 12 m detection distance and 88.5°/80° viewing angles



Additional K-band microwave sensor to filter thermal interferences



SmartDetect software algorithm to prevent false alarms



Immunity to pets weighing of up to 20 kg and below 50 cm height

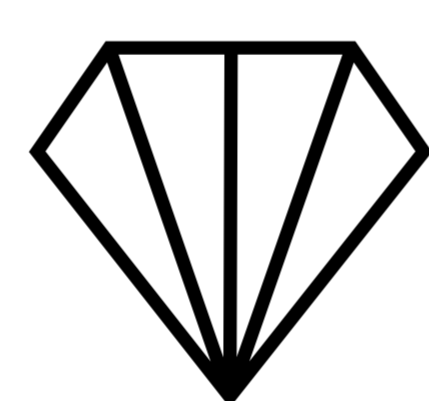
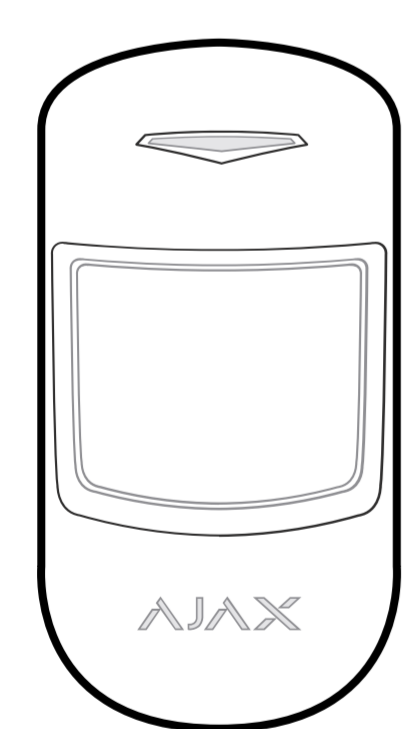

## Fibra

### communication technology

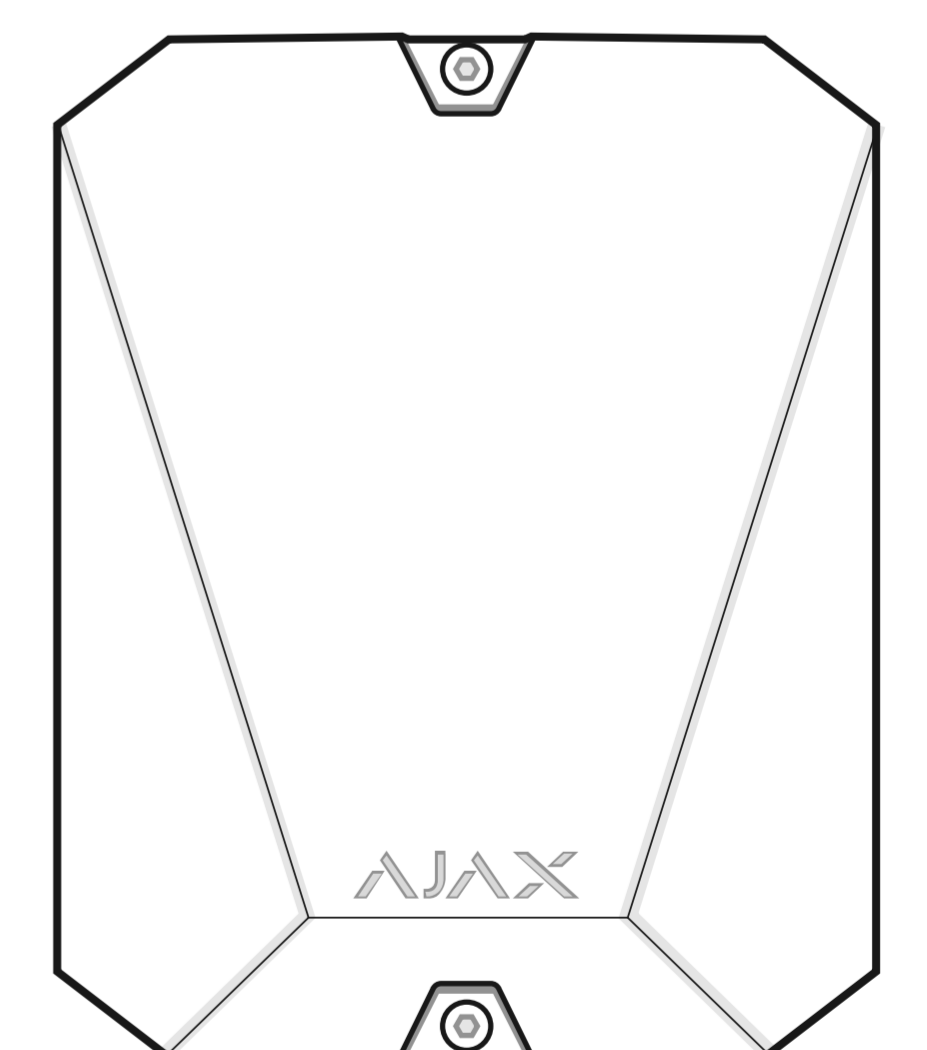

**Fibra** is a **two-way wired protocol**, ensuring fast and secure communication between hubs and devices. Based on a **bus connection method**, Fibra delivers instant data-rich alarms: security companies and users know which device was triggered, when and where it happened.

Fibra features **encryption** and **authentication** to prevent forgery, as well as **polling** to display device's status in real time. Supporting **up to 2,000 m** of wired connectivity, Fibra is ready to protect any facilities, and deliver **the best user experience** for both end users and installers.

# PIR sensor viewing angles

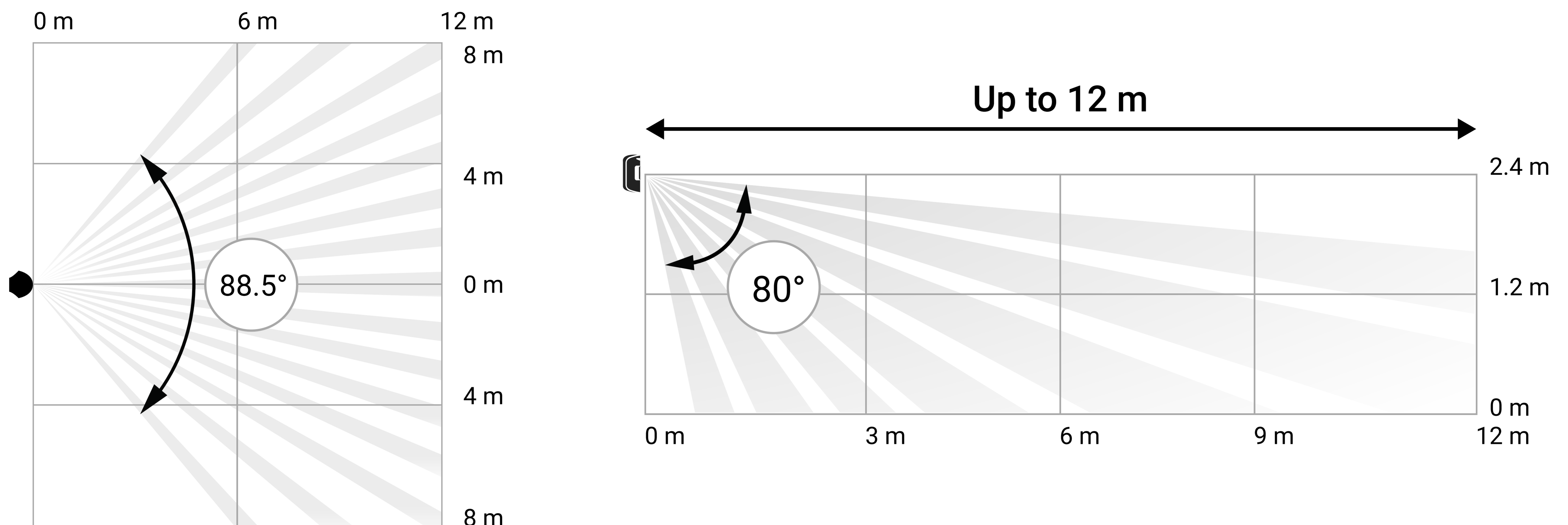

## System features

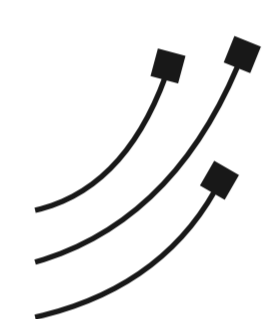

Connecting to the hub via bus method

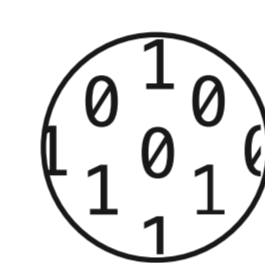

Up to 2,000 m of two-way encrypted communication

12-300  
sec

Adjustable polling interval

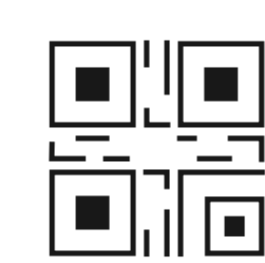

Adding to the security system via QR code or bus scanning



Remote configuring via the smartphone or desktop app

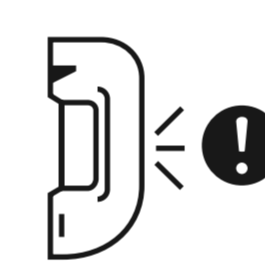

Tampering alarm notification

## Technical specifications

Compliance with standards	EN 50131 (Grade 2) PD 6662:2017	Compatibility	<b>Hubs</b> Hub Hybrid (2G) Hub Hybrid (4G)  <b>Range extenders</b> no
Communication with control panel	 <b>Fibra communication technology</b>	Motion detection	<b>Sensitive elements</b> PIR sensor K-band microwave sensor

<p>Communication with control panel</p> <p><b>Communication range</b> up to 2,000 m With U/UTP cat.5, 4×2×0.51 cable</p> <p><b>Polling interval</b> 12–300 sec Adjusted by PRO or user with admin rights in the Ajax app</p>	<p>Motion detection</p> <p><b>Motion detection distance</b> up to 12 m</p> <p><b>Detection angles</b> horizontal – 88.5° vertical – 80°</p> <p><b>Sensitivity</b> 3 levels Adjusted by PRO or user with admin rights in the Ajax app</p> <p><b>Pet immunity</b> weight: up to 20 kg height: up to 50 cm SmartDetect software algorithm filtering false alarms</p>
<p>Power supply</p> <p>24 V<math>\overline{=}</math>, up to 50 <math>\mu</math>A</p>	<p>Installation</p> <p><b>Operating temperature range</b> from –10°C to +40°C</p> <p><b>Operating humidity</b> up to 75%</p> <p><b>Protection class</b> IP50</p>
<p>Casing</p> <p><b>Colour</b> white, black</p> <p><b>Dimensions</b> 110 × 67 × 62 mm</p> <p><b>Weight</b> 86 g</p> <p><b>Tampering alarm</b></p>	<p>Complete set</p> <p>MotionProtect Plus Fibra SmartBracket mounting panel Installation kit Quick Start Guide</p>